



# Components for Entertainment Electronics

Satellite Sound IF

TDA6170X  
with Wegener Expander

**Edition 07.99**  
**Published by Siemens AG,**  
**Bereich Halbleiter, Marketing-**  
**Kommunikation, Balanstraße 73,**  
**81541 München**

© Siemens AG 1995.

All Rights Reserved.

**Attention please!**

As far as patents or other rights of third parties are concerned, liability is only assumed for components, not for applications, processes and circuits implemented within components or assemblies.

The information describes the type of component and shall not be considered as assured characteristics.

Terms of delivery and rights to change design reserved.

For questions on technology, delivery and prices please contact the Semiconductor Group Offices in Germany or the Siemens Companies and Representatives worldwide (see address list).

Due to technical requirements components may contain dangerous substances. For information on the types in question please contact your nearest Siemens Office, Semiconductor Group.

Siemens AG is an approved CECC manufacturer.

**Packing**

Please use the recycling operators known to you. We can also help you – get in touch with your nearest sales office. By agreement we will take packing material back, if it is sorted. You must bear the costs of transport.

For packing material that is returned to us unsorted or which we are not obliged to accept, we shall have to invoice you for any costs incurred.

**Components used in life-support devices or systems must be expressly authorized for such purpose!**

Critical components<sup>1</sup> of the Semiconductor Group of Siemens AG, may only be used in life-support devices or systems<sup>2</sup> with the express written approval of the Semiconductor Group of Siemens AG.

- 1 A critical component is a component used in a life-support device or system whose failure can reasonably be expected to cause the failure of that life-support device or system, or to affect its safety or effectiveness of that device or system.
- 2 Life support devices or systems are intended (a) to be implanted in the human body, or (b) to support and/or maintain and sustain human life. If they fail, it is reasonable to assume that the health of the user may be endangered.

**Ausgabe 07.99**  
**Herausgegeben von Siemens AG,**  
**Bereich Halbleiter, Marketing-**  
**Kommunikation, Balanstraße 73,**  
**81541 München**

© Siemens AG 1995.

Alle Rechte vorbehalten.

**Wichtige Hinweise!**

Gewähr für die Freiheit von Rechten Dritter leisten wir nur für Bauelemente selbst, nicht für Anwendungen, Verfahren und für die in Bauelementen oder Baugruppen realisierten Schaltungen.

Mit den Angaben werden die Bauelemente spezifiziert, nicht Eigenschaften zugesichert.

Liefermöglichkeiten und technische Änderungen vorbehalten.

Fragen über Technik, Preise und Liefermöglichkeiten richten Sie bitte an den Ihnen nächstgelegenen Vertrieb Halbleiter in Deutschland oder an unsere Landesgesellschaften im Ausland.

Bauelemente können aufgrund technischer Erfordernisse Gefahrstoffe enthalten.

Auskünfte darüber bitten wir unter Angabe des betreffenden Typs ebenfalls über den Vertrieb Halbleiter einzuholen.

Die Siemens AG ist ein Hersteller von CECC-qualifizierten Produkten.

**Verpackung**

Bitte benutzen Sie die Ihnen bekannten Verwerter. Wir helfen Ihnen auch weiter – wenden Sie sich an Ihren für Sie zuständigen Vertrieb Halbleiter. Nach Rücksprache nehmen wir Verpackungsmaterial sortiert zurück. Die Transportkosten müssen Sie tragen.

Für Verpackungsmaterial, das unsortiert an uns zurückgeliefert wird oder für das wir keine Rücknahmepflicht haben, müssen wir Ihnen die anfallenden Kosten in Rechnung stellen.

**Bausteine in lebenserhaltenden Geräten oder Systemen müssen ausdrücklich dafür zugelassen sein!**

Kritische Bauelemente<sup>1</sup> des Bereichs Halbleiter der Siemens AG dürfen nur mit ausdrücklicher schriftlicher Genehmigung des Bereichs Halbleiter der Siemens AG in lebenserhaltenden Geräten oder Systemen<sup>2</sup> eingesetzt werden.

- 1 Ein kritisches Bauelement ist ein in einem lebenserhaltenden Gerät oder System eingesetztes Bauelement, bei dessen Ausfall berechtigter Grund zur Annahme besteht, daß das lebenserhaltende Gerät oder System ausfällt bzw. dessen Sicherheit oder Wirksamkeit beeinträchtigt wird.
- 2 Lebenserhaltende Geräte und Systeme sind (a) zur chirurgischen Einpflanzung in den menschlichen Körper gedacht, oder (b) unterstützen bzw. erhalten das menschliche Leben. Sollten sie ausfallen, besteht berechtigter Grund zur Annahme, daß die Gesundheit des Anwenders gefährdet werden kann.

---

**TDA6170X****Revision History: Current Version: 07.99**

---

Previous Version:

old Page	new Page	Subjects (major changes since last revision)

**Data Classification****Maximum Ratings**

Maximum ratings are absolute ratings; exceeding only one of these values may cause irreversible damage to the integrated circuit.

**Characteristics**

The listed characteristics are ensured over the operating range of the integrated circuit. Typical characteristics specify mean values expected over the production spread. If not otherwise specified, typical characteristics apply at  $T_A = 25\text{ }^\circ\text{C}$  and the given supply voltage.

**Operating Range**

In the operating range the functions given in the circuit description are fulfilled.

For detailed technical information about "**Processing Guidelines**" and "**Quality Assurance**" for ICs, see our "**Product Overview**".

<b>1</b>	<b>Features</b> .....	<b>1</b>
<b>2</b>	<b>Pinning</b> .....	<b>1</b>
<b>3</b>	<b>Ordering Information</b> .....	<b>1</b>
<b>4</b>	<b>General Description</b> .....	<b>1</b>
4.1	Application .....	1
<b>5</b>	<b>Pinconfiguration</b> .....	<b>2</b>
5.1	Package outline P-DSO-28-1 .....	2
<b>6</b>	<b>Pin Definitions and Functions</b> .....	<b>3</b>
<b>7</b>	<b>Block Diagram</b> .....	<b>4</b>
<b>8</b>	<b>Circuit Description</b> .....	<b>5</b>
8.1	General .....	5
8.2	PLL Description .....	5
8.3	Fast I <sup>2</sup> C-Bus Interface .....	5
8.3.1	Logic Allocation .....	6
8.3.2	IF-Muting .....	6
8.4	Converter Mixer .....	6
8.5	IF Limiter with Demodulator .....	6
8.6	Expander Description .....	7
8.7	AF Switch and Volume Control .....	7
<b>9</b>	<b>Pinning</b> .....	<b>8</b>
<b>10</b>	<b>Absolute Maximum Ratings</b> .....	<b>15</b>
<b>11</b>	<b>Operating Range</b> .....	<b>16</b>
<b>12</b>	<b>Electrical Characteristics</b> .....	<b>17</b>
<b>13</b>	<b>Application Circuit</b> .....	<b>21</b>
<b>14</b>	<b>Test circuit</b> .....	<b>22</b>
<b>15</b>	<b>Diagrams</b> .....	<b>23</b>
15.1	I <sup>2</sup> C-Bus Timing .....	23

## 1 Features

- Fast I<sup>2</sup>C-bus controlled (max. 400 kHz)
- PLL controlled sound IF tuning with 10 kHz stepwidth
- Second order high-pass mixer input
- IF MUX for 10.7 MHz broad / small IF filters
- Two identical high sensitive alignment free FM demodulators
- Original Wegener PANDA 1<sup>TM</sup> expander
- Volume control for individual settings
- 50 μs / 75 μs / J17 de-emphasis for main sound reception
- Fully ESD protection

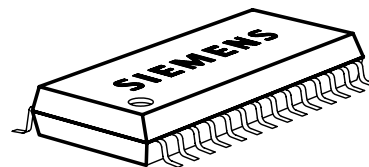

**P-DSO-28**

## Package

## 2 Ordering Information

Type	Package	Ordering Code
TDA6170X	P-DSO-28-1	Q67001-A5214

## 3 General Description

Multistandard satellite sound IF device consisting of a mixer and a voltage controlled oscillator (VCO) as a frequency converter that can be continuously tuned in 10 kHz increments with crystal accuracy by means of a PLL, two FM limiter amplifiers with PLL FM demodulators followed by two Wegener PANDA1<sup>TM</sup> expanders. The AF signal passes through two switches. Each switch can select the AF sources and the mono / stereo mode the de-emphasis networks together with the two following volume control stages with audio buffers. In front of one FM section an IF multiplexer is used to select the IF bandwidth. The switching functions and settings of the PLL are controlled by an I<sup>2</sup>C-bus.

### 3.1 Application

- For use in satellite receivers

## 4 Pinconfiguration

P-DSO 28-1

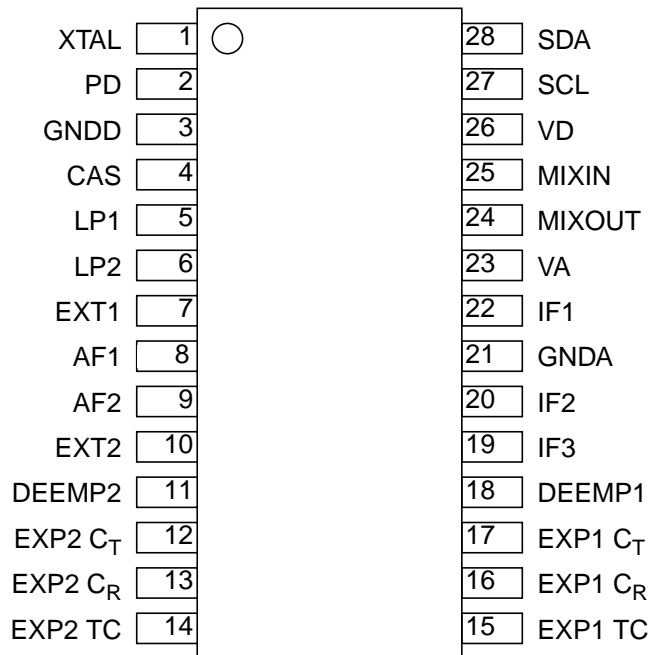

### 4.1 Package outline P-DSO-28-1

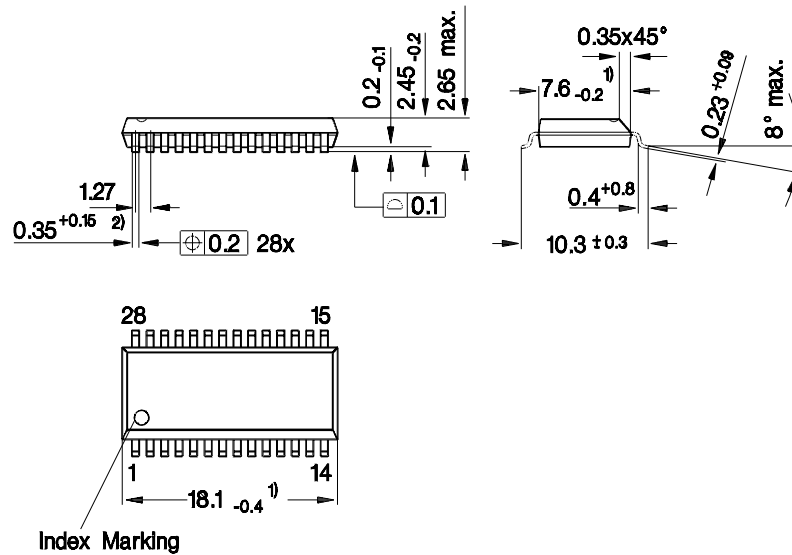

- 1) Does not include plastic or metal protrusion of 0.15 max. per side
- 2) Does not include dambar protrusion

## 5 Pin Definitions and Functions

Pin No.	Symbol	Function
1	XTAL	crystal input for 4 MHz oscillator
2	PD	synthesizer loop-filter
3	GNDD	I <sup>2</sup> C-bus and synthesizer ground
4	CAS	I <sup>2</sup> C-bus address selection
5	LP1	FM-PLL lowpass capacitor (channel 1)
6	LP2	FM-PLL lowpass capacitor (channel 2)
7	EXT1	external audio input (channel 1)
8	AF1	audio output (channel 1)
9	AF2	audio output (channel 2)
10	EXT2	external audio input (channel 2)
11	DEEMP2	de-emphasis capacitor (channel 2)
12	EXP2 C <sub>T</sub>	expander tracking capacitor (channel 2)
13	EXP2 C <sub>R</sub>	expander release capacitor (channel 2)
14	EXP2 TC	expander time constant (channel 2)
15	EXP1 TC	expander time constant (channel 1)
16	EXP1 C <sub>R</sub>	expander release capacitor (channel 1)
17	EXP1 C <sub>T</sub>	expander tracking capacitor (channel 1)
18	DEEMP1	de-emphasis capacitor (channel 1)
19	IF3	intercarrier input 3
20	IF2	intercarrier input 2
21	GNDA	analog ground
22	IF1	intercarrier input 1
23	VA	analog supply voltage (+8V)
24	MIXOUT	intercarrier mixer output
25	MIXIN	mixer input
26	VD	I <sup>2</sup> C-bus and synthesizer supply voltage (+5V)
27	SCL	I <sup>2</sup> C-bus serial clock input
28	SDA	I <sup>2</sup> C-bus serial data input/output

## 6 Block Diagram

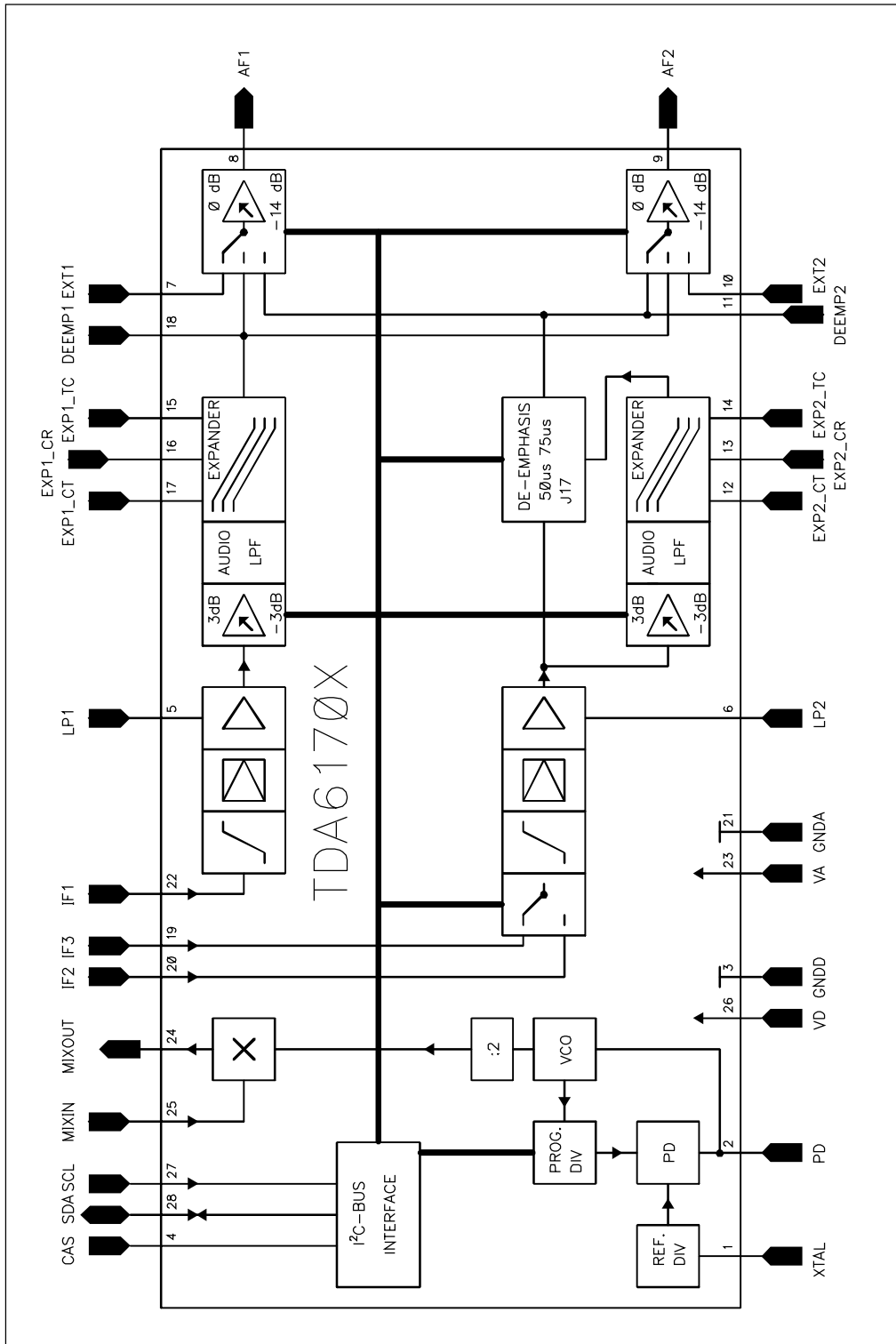



## 7 Circuit Description

### 7.1 General

The sound intermediate frequencies contained in the baseband of a demodulated FM satellite signal can lie between 5 and 9.9 MHz. This band of frequencies is applied rough filtered to the high-pass input of the converter mixer. The purpose of this mixer is to convert the different sound IF's in the baseband to fixed output frequencies (e.g. 10.7 / 10.72 MHz). These frequencies are then fed by external filters to the three sound IF inputs.

The VCO of the mixer can be continuously tuned between 29 and 40 MHz in 20 kHz increments with crystal accuracy by means of a PLL circuit.

The settings of the programmable divider and switching of the IF MUX and de-emphasis networks and volume control are done by the I<sup>2</sup>C-bus.

Pin 5 (CAS) offers two switchable chip addresses to enable parallel operation of two devices.

All pins are guarded against electrostatic discharge. SCL and SDA include special protective structures to permit continued bus operation when the device is switched off.

### 7.2 PLL Description

The VCO signal is applied to the PLL input. It passes through a programmable divider (N=1024 to 2047) and then compared with a reference frequency ( $f_{REF} = 20$  kHz in a digital frequency / phase detector. This frequency is derived from a 4 MHz crystal oscillator whose signal is divided by 200.

The phase detector has a charge pump push-pull current output. If the negative edge of the divided VCO signal appears before the negative edge of the reference signal, the current source I+ will pulse for the duration of the phase difference. In the reverse case it is the current sink I-. If both signals are in phase, the output has a high impedance and the PLL is locked. The current pulses are filtered by means of an integrator.

The pump current can be switched between two values (1 and 5) by software with a control bit 5I. This permits a change in the control response during and after lock-in state.

### 7.3 Fast I<sup>2</sup>C-Bus Interface

Information is exchanged between the processor and the sound IF device on an fast asynchronous bidirectional data bus. The timing for this comes from the processor (input SCL), while pin SDA functions as an I/O depending on the direction of the data (open collector; external pull-up resistor). The bus will work with clock frequencies up to 400 kHz.

The data from the processor goes to an I<sup>2</sup>C-bus controller and are put into registers (latches 0 to x) according to their function. When the bus is not busy, both lines are in the marking state (SDA, SCL are high). Each telegram begins with the start condition: SDA goes low while SCL remains high. All further exchanges of information occur when SCL is low and are read by the controller with the positive clock edge. If SDA goes high while the clock is high, the I<sup>2</sup>C-bus interface recognizes this as a stop condition and thus the end of the telegram.

For what follows, refer to the table of logic assignments below.

All telegrams are transferred byte for byte, followed by a ninth clock pulse during which the controller pulls the SDA line to low (i.e. acknowledge condition). The first byte consists of seven address bits with which the processor selects the PLL from among several other peripheral devices (chip select). The eighth bit is always low. The first bit of the first or third data byte in the data part of the telegram determines whether a divider ratio or control information for the IF or audio part will follow. In every case the first byte must be followed by a byte of the same data type (or stop condition). When the supply voltage is applied, a power-on reset circuit prevents the PLL from pulling the SDA line to low and thus blocking the bus.

### 7.3.1 Logic Allocation

Byte	Data									Remarks
Address Byte	0	1	0	0	0	0	MA	R/W	A	
Progr. Divider Byte 1	0	0	N11	N10	N9	N8	N7	N6	A	
Progr. Divider Byte 2	0	0	N5	N4	N3	N2	N1	N0	A	
Control Byte 1	1	5I	Z2	Z1	Z0	X	X	X	A	
Control Byte 2	1	VL2	VL1	VL0	VR2	VR1	VR0	X	A	
Control Byte 3	1	PVL2	PVL1	PVL0	PVR2	PVR1	PVR0	X	A	
Address Byte 1 <sup>1</sup>	0	1	0	0	0	1	0	0	A	=H44
Address Byte 2 <sup>2</sup>	0	1	0	0	0	1	1	0	A	=H46

1. Chip address (CAS) Pin 5 grounded

2. Chip address (CAS) Pin 5 open

### 7.3.2 IF-Muting

Control Bits			IF-Source			Function
Z2	Z1	Z0	IF1	IF2	IF3	
0	0	0	on	on	off	expanders are working, audio = stereo
0	0	1	off	on	off	expanders are working, audio = mono
0	1	0	on	off	off	expanders are working, audio = mono
0	1	1	off	off	on	de-emphasis = 50µ; audio = mono
1	0	0	off	off	on	de-emphasis = 75µ; audio = mono
1	0	1	off	off	on	de-emphasis = J17; audio = mono
1	1	0	off	off	off	External audio
1	1	1	off	off	off	Mute

### 7.4 Converter Mixer

In the converter mixer the sound subcarriers (frequency band approx. 5 to 9.9 MHz) contained in the base-band of the received composite satellite signal are converted to an output frequency of 10.52 MHz and 10.7 MHz for example. The converter consists of a high-pass input filter followed by a double balanced mixer and a low impedance output.

The signal of the on chip voltage controlled oscillator (VCO) is applied to the PLL input.

### 7.5 IF Limiter with Demodulator

The two limiter amplifiers are implemented as balanced five stage, capacitively coupled differential amplifiers. The three inputs are designed as high-pass inputs. The load resistors for the IF filters are connected to ground.

The output signals of the limiter amplifiers are fed directly to the internal PLL FM demodulators.

The demodulated AF signals are fed to the input of a pre volume control part in front of the expander the de-emphasis networks and audio switches.

## 7.6 Expander Description

The demodulated and level controlled audio signals are fed via low-pass filters to the inputs of two identical expander circuits. The IF3 audio signal is also applied in parallel via different de-emphasis networks to the input of the audio switch for broadband mono reception. The expander circuits have the reverse characteristics of the audio compressor of the TV station. A 3 bit pre volume control (control byte 3: PVL2...PVL0 and PVR2...PVR0) for each audio channel enables a correct adjustment of the expander characteristics and allows the possibility to align to the right level for both broadband and smallband sound IF reception.

## 7.7 AF Switch and Volume Control

The input signals of the AF switch can be derived from the external audio input pair. However, these signals can also be derived from either the different de-emphasis networks or from both expanders. The selection of the output signals from IF1, IF2 or IF3 is done by using the I<sup>2</sup>C-bus interface. The switches are followed by a volume control section with buffered outputs Ch1 and Ch2.

In case of small-band reception the demodulated signals of IF1 and IF2 are processed in both expanders and fed to the switches. So it is possible to select one of each or both in the audio switches for both AF outputs Ch1 and Ch2.

In the case of broad-band audio transmission with 50µs, 75µs or J17 pre-emphasis the IF3 input is active and with the audio switch the demodulated audio signals are selected after the three de-emphasis networks and fed to both AF outputs in mono mode.

The 3 bit volume control (control byte 2: VL2...VL0 and VR2...VR0) in front of each AF output enables the same audio level for different FM deviations of several satellite transponders.

## 8 Pinning

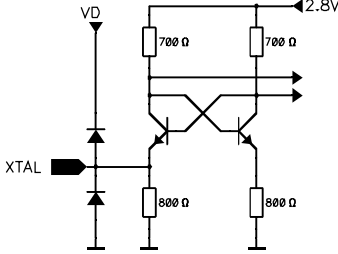
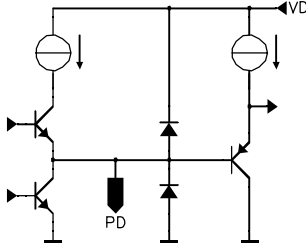
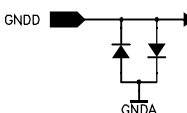
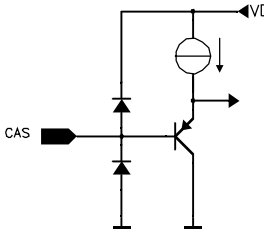
Pin No.	Symbol	Equivalent Circuit
1	XTAL	
2	PD	
3	GNDD	
4	CAS	

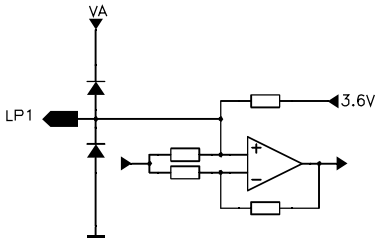
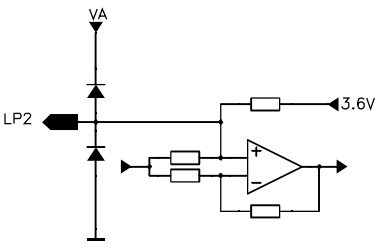
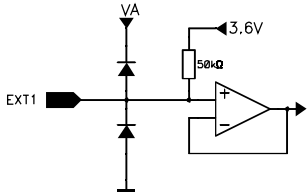
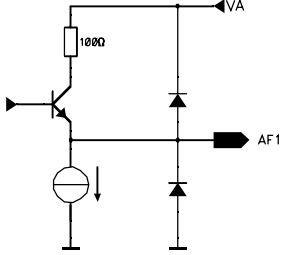
Pin No.	Symbol	Equivalent Circuit
5	LP1	
6	LP2	
7	EXT1	
8	AF1	

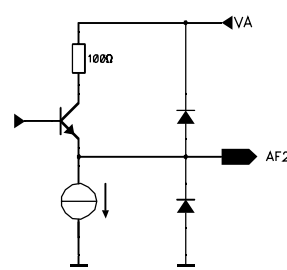
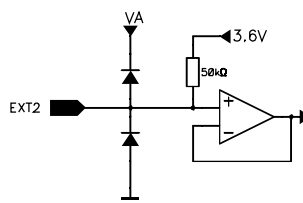
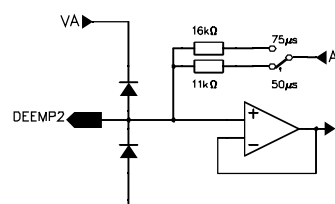
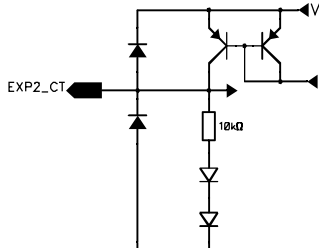
Pin No.	Symbol	Equivalent Circuit
9	AF2	
10	EXT2	
11	DEEMP2	
12	EXP2 C <sub>T</sub>	

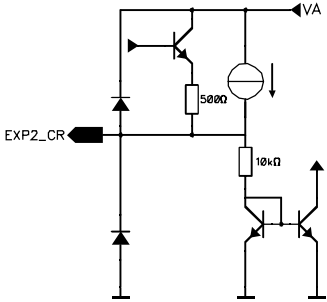
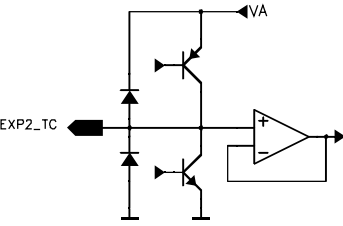
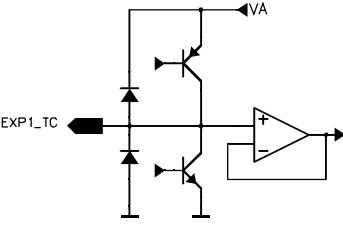
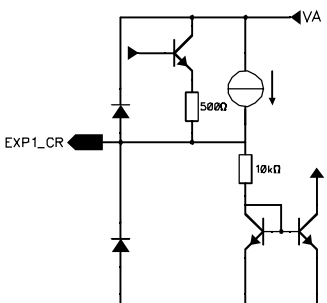
Pin No.	Symbol	Equivalent Circuit
13	EXP2 C <sub>R</sub>	
14	EXP2 TC	
15	EXP1 TC	
16	EXP1 C <sub>R</sub>	

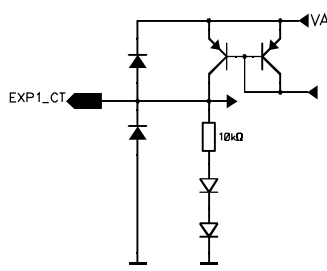
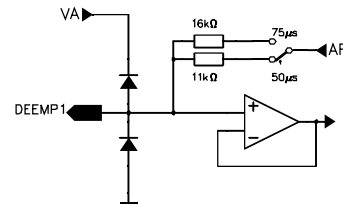
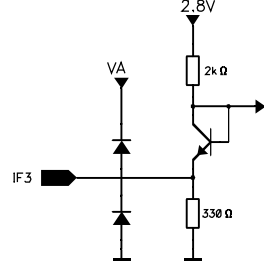
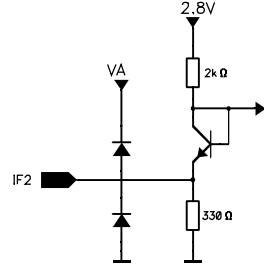
Pin No.	Symbol	Equivalent Circuit
17	EXP1 C <sub>T</sub>	
18	DEEMP1	
19	IF3	
20	IF2	

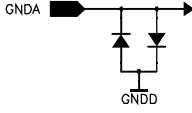
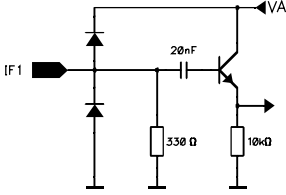
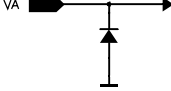
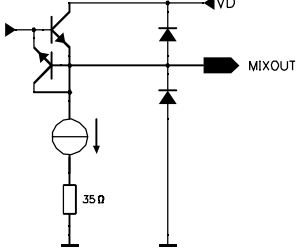

Pin No.	Symbol	Equivalent Circuit
21	GNDA	
22	IF1	
23	VA	
24	MIXOUT	

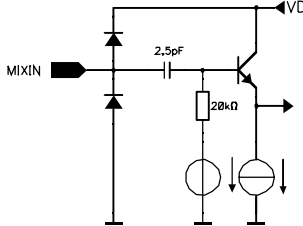
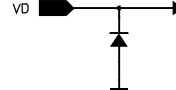
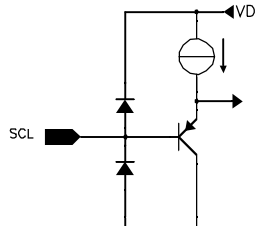
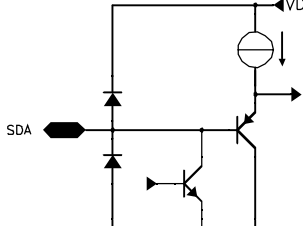
Pin No.	Symbol	Equivalent Circuit
25	MIXIN	
26	VD	
27	SDA	
28	SCL	

## 9 Absolute Maximum Ratings

*The maximal ratings may not be exceeded under any circumstances, not even momentary and individual, as permanent damage to the IC will result.*

Ambient Temperature under bias:  $T_A=0$  to  $70^{\circ}\text{C}$

Parameter	Symbol	Limit Values		Unit	Test Conditions
		min	max		
Supply voltage (digital)	$V_{VD}$	0	6	V	
Supply voltage (analog)	$V_{VA}$	0	13.2	V	
Mixer input	$V_{MIXIN}$	-0.3	13.2	V	
IF inputs	$V_{IF}$	-0.3	1	V	
Crystal oscillator	$V_{XTAL}$	0	1.5	V	
SDA; SCL; CAS	V	-0.3	6	V	
Junction temperature	$T_j$	0	150	$^{\circ}\text{C}$	
Storage temperature	$T_{stg}$	0	125	$^{\circ}\text{C}$	
Thermal resistance	$R_{th\ j-a}$		75	K/W	
ESD-Protection	$V_{ESD}$		2	kV	all pins

All values are referred to ground (pin), unless stated otherwise.

All currents are designated according to the source and sink principle, i.e. if the device pin is to be regarded as a sink (the current flows into the stated pin to internal ground), it has a negative sign, and if it is a source (the current flows from  $V_s$  across the designated pin), it has a positive sign.

## 10 Operating Range

*Within the operational range the IC operates as described in the circuit description.  
The AC / DC characteristic limits are not guaranteed.*

Parameter	Symbol (Name)	Limit Values		Unit	Test Conditions
		min	max		
Supply voltage (digital)	$V_{VD}$	4.5	5.5	V	
Supply voltage (analog)	$V_{VA}$	7.2	13.2	V	
Input frequency range of converter mixer	$f_{MIXIN}$	5	10	MHz	
Input frequency range of sound IF amplifier	$f_{IF}$	10	12	MHz	
VCO frequency	$f_{VCO}$	29	42	MHz	
Ambient temperature	$T_A$	0	70	°C	

## 11 Electrical Characteristics

AC / DC characteristics involve the spread of values guaranteed in the specified supply voltage and ambient temperature range. Typical characteristics are the median of the production.

Parameter	Symbol	Limit Values			Unit	Test conditions
		min	typ	max		
<b>Power Supply</b>						
Current consumption $V_{\text{digital}}$	$I_{\text{VD}}$	30	40	50	mA	
Current consumption $V_{\text{analog}}$	$I_{\text{VA}}$	30	40	50	mA	
<b>Mixer</b>						
Mixer input voltage	$V_{\text{MIXIN(rms)}}$			200	mV	
Mixer output current	$I_{\text{MIXOUT}}$	4	6	8	mA	
Input impedance	$R_{\text{MIXIN}}$	3.5			k $\Omega$	
Output frequency range	$f_{\text{MIXOUT}}$	10	10.7	11.5	MHz	
Mixer gain	$G_{\text{MIX}}$	2	3	4	dB	$R_L = 100 \Omega$
<b>Charge pump</b>						
Phase detector charge current	$I_{\text{PD}}$	32	50	75	$\mu\text{A}$	I
Phase detector charge current	$I_{\text{PD}}$	160	250	360	$\mu\text{A}$	5I
repetition time of charge pump pulses	t		50		$\mu\text{s}$	
<b>VCO</b>						
Frequency range VCO	$\Delta f_{\text{VCO}}$	29		43	MHz	
VCO frequency	$f_{\text{VCO}}$		35.5		MHz	$V_{\text{PD}} = 2.5\text{V}$
VCO sensitivity	$S_{\text{VCO}}$		-16		MHz/V	
<b>Crystal oscillator (4 MHz)</b>						
crystal oscillator frequency	$f_{\text{xtal}}$		4		MHz	
resonance resistance of crystal	$R_{\text{xtal}}$			60	W	
parallel capacitance of crystal	$C_{\text{xtal}}$		4.5	10	pF	
input current from external source	$I_i$	50			$\mu\text{A}$	
<b>Sound IF</b>						
Sound IF input resistance	$R_{\text{IF}}$	260	330	400	W	
Input frequency range	$f_{\text{IF}}$	10		11.5	MHz	
Input sensitivity	$V_{\text{IF(rms)}}$		0.3	1	mV	S/N(A) > 40 dB; $f_{\text{IF}} = 10.7 \text{ MHz}$ ; $\Delta f = 27 \text{ kHz}$ ; $f_{\text{mod}} = 1 \text{ kHz}$
AM rejection	$a_{\text{AM}}$	45			dB	$f_{\text{IF}} = 10.7 \text{ MHz}$ ; $V_{\text{IF}} = 5 \text{ to } 100\text{mV}$ ; $f_{\text{mod}} = 30\%$

Parameter	Symbol	Limit Values			Unit	Test conditions
		min	typ	max		
<b>FM PLL demodulators</b>						
free-running frequency	$f_{CCO}$		10.6		MHz	
lock range of PLL	$\Delta f_{CCO}$	10		11.5	MHz	
<b>Expander</b>						
Pre volume control range	$\Delta PV$	2.5 -3.5	3 -3	3.5 -2.5	dB	PVL = 000 PVL = 111
Control resolution	$\delta V$	0.6	0.8	1	dB	
Low-pass filter response		16	20	24	kHz	
<b>AF Switch and Volume Control</b>						
Max. external input voltage	$V_{EXT(rms)}$			2	V	
Volume control range	$\Delta V$	-1 -12	0 -14	1 -16	dB	VL = 000 VL = 111
Control resolution	$\delta V$	1.6	2	2.4	dB	
<b>Output Buffer</b>						
Output DC level	$V_{AF}$		3.6		V	
Output resistance	$R_{AF}$	100	125	150	W	
total harmonic distortion	THD		0.01	0.2	%	
signal to noise ratio	S/N (A)	80			dB	A-weighted $V_{EXT} = 500 \text{ mV}_{rms}$ Control Byte = 110
crosstalk between channels	$\alpha_{L/R};$ $\alpha_{R/L}$	80			dB	$V_{EXT} = 2 V_{rms}$ $f = 1 \text{ kHz}$ Control Byte = 110
<b>Overall performance</b>						
Input voltage	$V_{MIXIN}$		0.5	1	mV	S/N > 40 dB $\Delta f = 27\text{kHz}$ , Control Byte = 000
			1.5	3	mV	S/N > 40 dB $\Delta f = 50\text{kHz}$ , Control Byte = 011
Output voltage	$V_{AF}$	400	500	600	mV	$\Delta f = 27\text{kHz}$ , $f_{mod} = 1\text{kHz}$ , Control Byte = 000
		400	500	600	mV	$\Delta f = 50\text{kHz}$ , $f_{mod} = 1\text{kHz}$ , Control Byte = 011

Parameter	Symbol	Limit Values			Unit	Test conditions
		min	typ	max		
total harmonic distortion	THD		0.2	0.5	%	$V_{MIXIN} > 2 \text{ mV}$ $\Delta f = 27\text{kHz}$ , $f_{mod} = 1\text{kHz}$ , Control Byte = 000
			0.2	0.5	%	$V_{MIXIN} > 2 \text{ mV}$ $\Delta f = 50\text{kHz}$ , $f_{mod} = 1\text{kHz}$ , Control Byte = 011
signal to noise ratio	S/N	70	75		dB	A-weighted, $\Delta f = 27\text{kHz}$ , $f_{mod} = 1\text{kHz}$ , Control Byte = 000
Mute attenuation	a <sub>MUTE</sub>	75	90		dB	Control Byte = 111

**I<sup>2</sup>C-Bus Interface**

LOW level input voltage for both SDA and SCL	V <sub>IL</sub>	-0.5		1.5	V	
HIGH level input voltage for both SDA and SCL	V <sub>IH</sub>	3		V <sub>VD</sub> + 0.5	V	
Hysteresis of Schmitt trigger inputs	V <sub>hys</sub>	0.2			V	
Pulse width of spikes which must be suppressed by the input filters	t <sub>SP</sub>			50	ns	
LOW level output voltage (open collector)	V <sub>OL1</sub> V <sub>OL2</sub>	0 0		0.4 0.6	V	3 mA sink current 6 mA sink current
Output fall time from V <sub>IHmin</sub> to V <sub>ILmax</sub> with a bus capacitance from 10 pF to 400 pF	t <sub>OF</sub>	20 + 0.1C <sub>b</sub>		250	ns	
Input current for both SDA + SCL	I <sub>i</sub>	-10		10	μA	
SCL clock frequency	f <sub>SCL</sub>	0		400	kHz	
Bus free time between a STOP and START condition	t <sub>BUF</sub>	1.3			μs	
Hold time (repeated) START condition. After this period, the first clock pulse is generated	t <sub>HD,STA</sub>	0.6			μs	
LOW period of the SCL clock	t <sub>LOW</sub>	1.3			μs	
HIGH period of the SCL clock	t <sub>HIGH</sub>	0.6			μs	
Set-up time for repeated START condition	t <sub>SU,DAT</sub>	0.6			μs	
Data hold time: for I <sup>2</sup> C-bus devices	t <sub>HD,DAT</sub>	0		0.9	μs	
Data set-up time	t <sub>SU,DAT</sub>	100			ns	
Rise time of both SDA + SCL	t <sub>R</sub>	20 + 0.1C <sub>b</sub>		300	ns	

Parameter	Symbol	Limit Values			Unit	Test conditions
		min	typ	max		
Fall time of both SDA + SCL	$t_F$	$20 + 0.1C_b$		300	ns	
Set-up time for STOP condition	$t_{SU,STO}$	0.6			$\mu s$	
Capacitive load for each bus line	$C_b$			400	pF	



## 12 Application Circuit

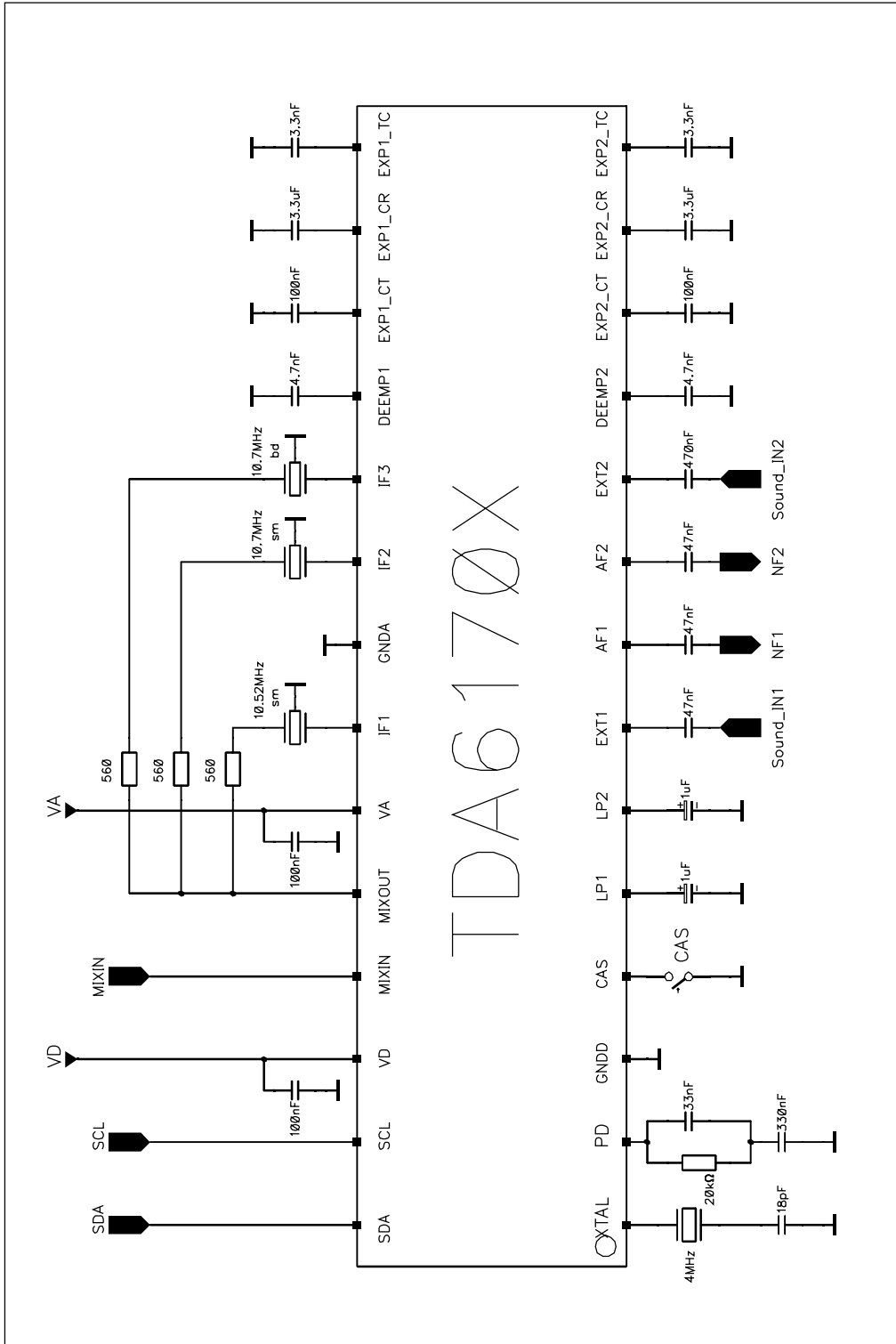

13 Test circuit

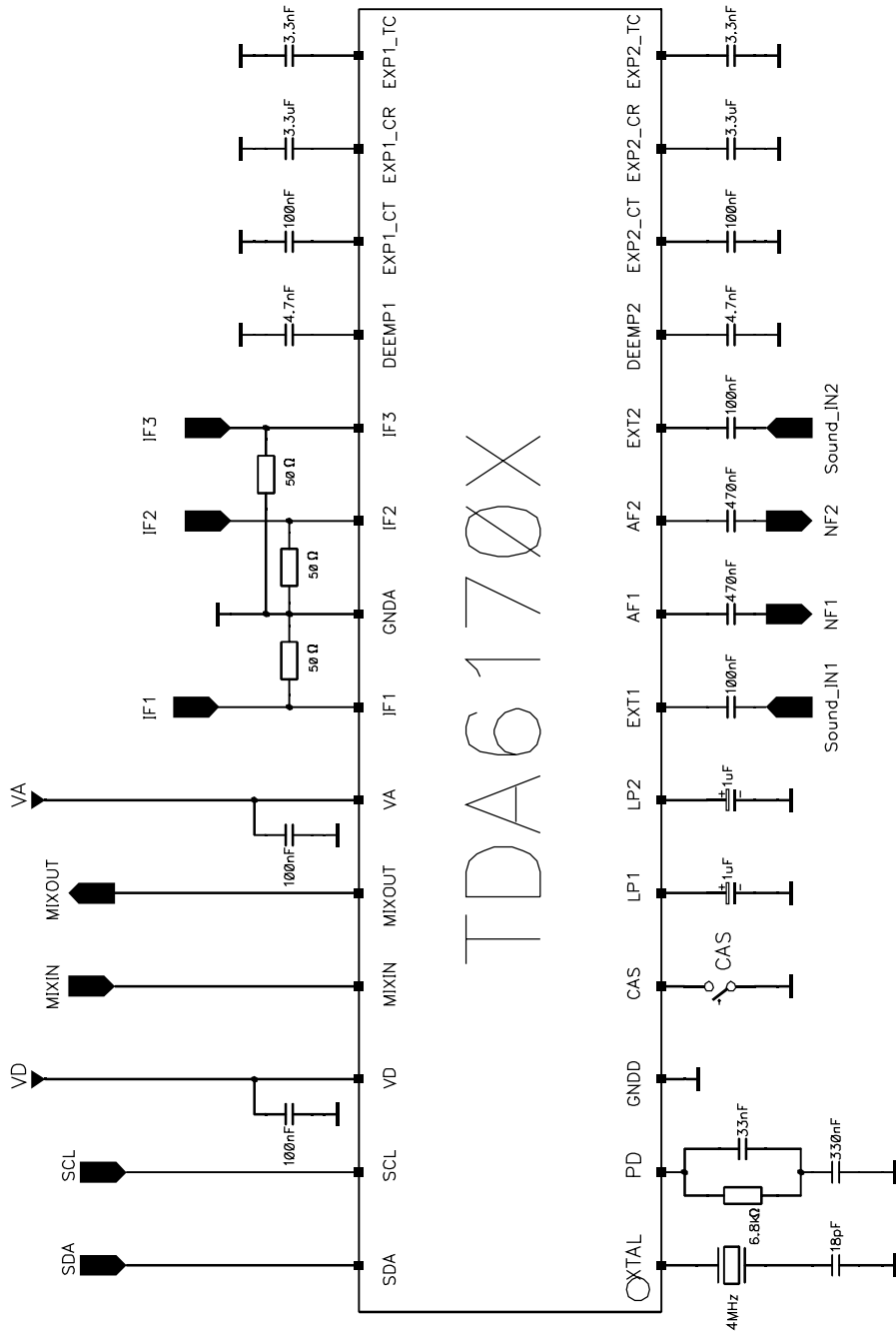

## 14 Diagrams

### 14.1 I<sup>2</sup>C-Bus Timing

